

# Schritt 4

Zu diesem Lernprogramm haben Sie neben dem Modell-Baukasten 1 auch noch den Modell-Baukasten 2 erhalten.

Kasten 1 kennen Sie bereits aus dem vorangegangenen Lernprogramm.

Bitte überprüfen Sie anhand der Abbildung und der folgenden Aufstellung mit den Kurzbezeichnungen erneut den Kasten 1 auf seine Vollständigkeit.

I,1 = große Platte \_\_\_\_\_ 4 Stück

I,2 = kleine Platte \_\_\_\_\_ 4 Stück

I,3 = Würfel \_\_\_\_\_ 20 Stück

I,4 = Halbwürfel \_\_\_\_\_ 8 Stück

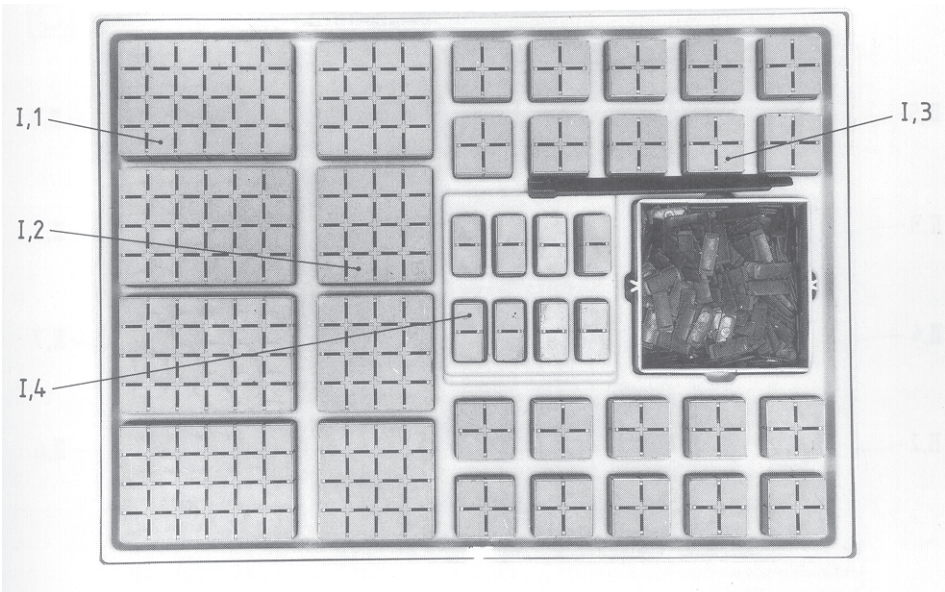

# Lernschritt 11 - Lösung

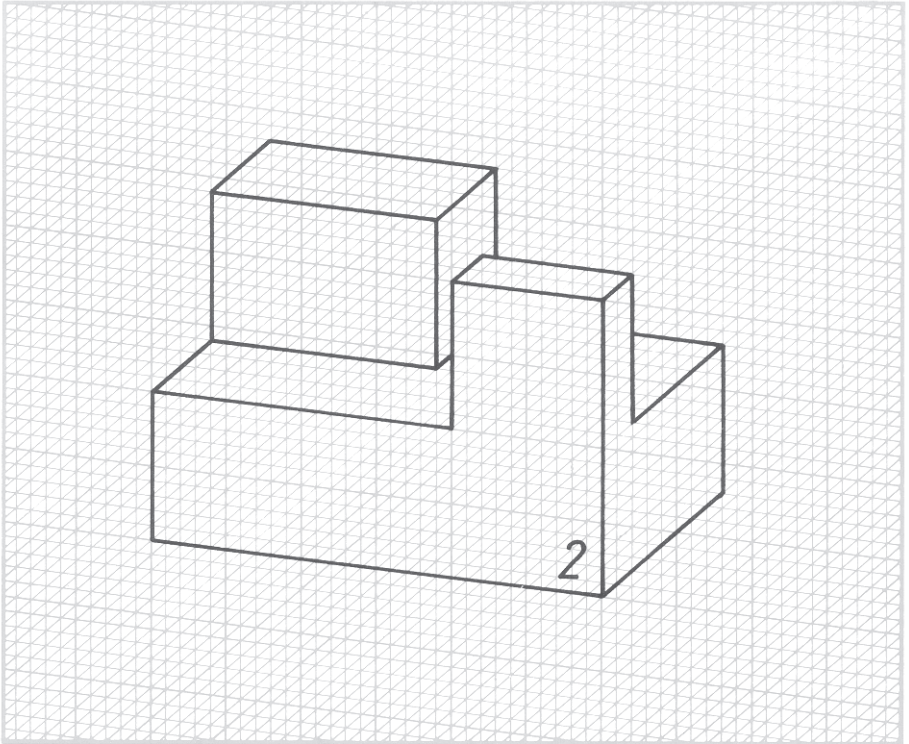

Falls Sie eine andere Lösung haben, korrigieren Sie bitte die Darstellung anhand dieser Abbildung.

# Lernschritt 21

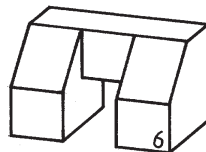
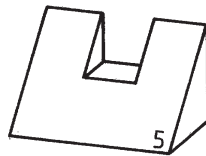
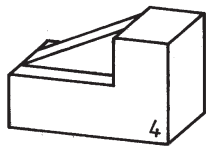
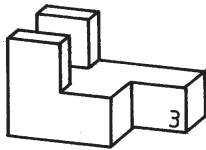
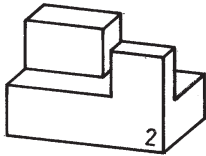
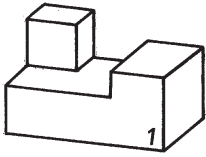

## Vorderansichten



a

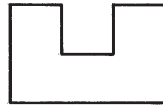

b

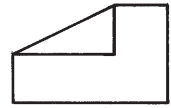

c

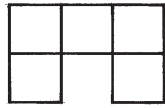

d

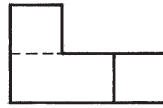

e

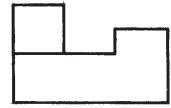

f

## Draufsichten

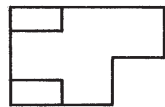

g

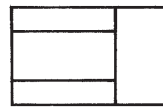

h

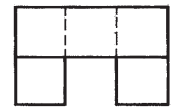

i

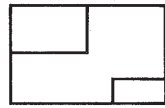

k

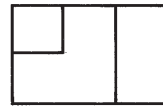

l

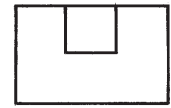

m

## Seitenansichten

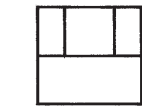

n

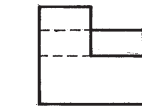

o

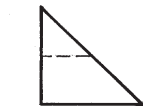

p

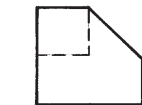

r

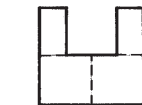

s



t

## Lernschritt 31 - Lösung

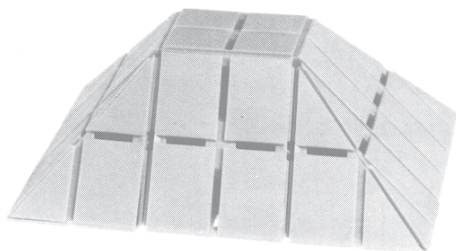

Falls der von Ihnen zusammengesteckte Körper anders aussieht, korrigieren Sie ihn bitte anhand dieser Abbildung.